

QLSP20XXEU-309
(High Power 2020 LED)



Product Outline:

QLSP20XXEU series are color LEDs bring high performance and quality of light to wide range of lighting application. The lighting application such as cation light, decoration light, signal, specific industrial and commercial lighting.

Features:

- High brightness output @ 350mA,
- High driving current to 1050mA
- Package Dimension = 2.0mmX2.0mmX0.85mm
- Low thermal resistance : <math><5^{\circ}\text{C}/\text{W}</math>
- ESD protection up to 8KV
- RoHS compliant
- Custom Bin available upon special request

Application:

- Architecture Lighting
- Garden Lighting
- Exterior Automotive Lighting
- Warming lamp
- Indoor Lighting
- Outdoor Lighting

Compliance and Certification:



Mechanical Property: (Dimension)

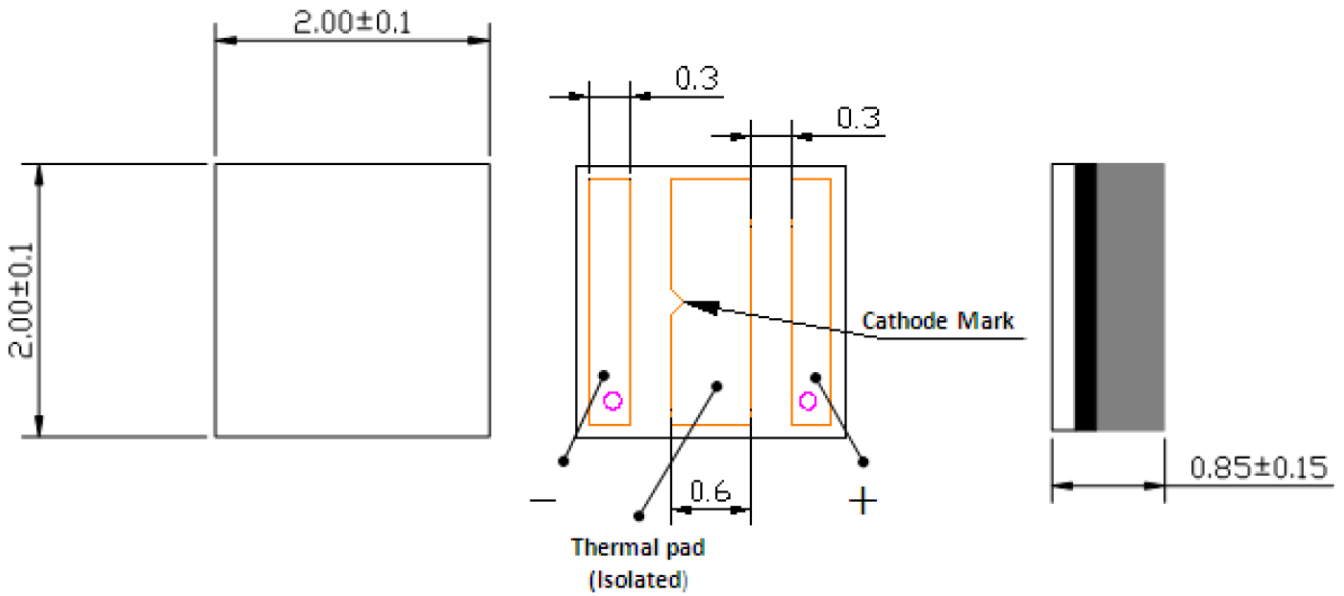

Recommended Solder footprint:

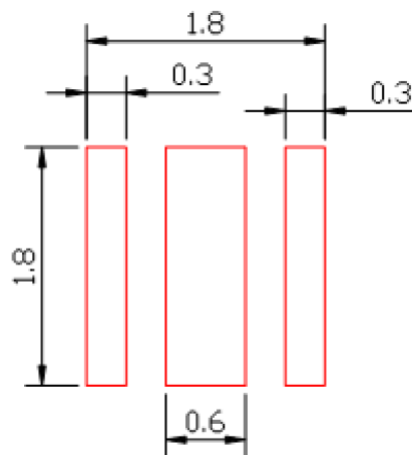

Electrical / Optical Characteristic

(T=25 °C)

| Product | Color | I _F (mA) | V _F (V) | | Wavelength nm (CCT) | Luminous Flux(lm) | | Refer @ 700mA Typ.(lm) |
|-------------|------------|---------------------|--------------------|-----|------------------------|-------------------|------|---------------------------|
| | | | Typ. | max | | min | typ. | |
| QLSP20RBEU | Royal Blue | 350 | 3.0 | 3.4 | 450~460 | 9 | 17 | 30 |
| QLSP20BEU | Blue | 350 | 3.0 | 3.4 | 465~480 | 31 | 40 | 71 |
| QLSP20GEU | Green | 350 | 3.0 | 3.4 | 515~535 | 100 | 120 | 210 |
| QLSP20PCAEU | PC Amber | 350 | 3.0 | 3.4 | NA | 100 | 105 | 190 |
| QLSP20REU | Red | 350 | 2.2 | 2.6 | 615~630 | 60 | 70 | 125 |
| QLSP20CWEU | Cold White | 350 | 3.0 | 3.4 | 5000K~6000K | 130 | 150 | 268 |

*Tolerance = +/- 7%

Absolute Maximum Rating

(T=25 °C)

| Part # | P _d (mW) | I _F (mA) | I _{FP} (mA)* | V _R (V) | T _j (°C) | TOP (°C) | T _{ST} (°C) | T _{SOL} (°C)** | R _{th(J-S)} (C/W)*** |
|-------------|---------------------|---------------------|-----------------------|--------------------|---------------------|----------|----------------------|-------------------------|----------------------------------|
| QLSP20RBEU | 4000 | 1050 | 1300 | 5 | 150 | -40~90 | -40~100 | 260 | 4 |
| QLSP20BEU | 4000 | 1050 | 1300 | 5 | 125 | -40~90 | -40~100 | 260 | 4 |
| QLSP20GEU | 4000 | 1050 | 1300 | 5 | 150 | -40~90 | -40~100 | 260 | 4 |
| QLSP20PCAEU | 4000 | 1050 | 1300 | 5 | 150 | -40~90 | -40~100 | 260 | 4 |
| QLSP20REU | 4000 | 1050 | 1300 | 5 | 125 | -40~90 | -40~100 | 260 | 5 |
| QLSP20CWEU | 4000 | 1050 | 1300 | 5 | 150 | -40~90 | -40~100 | 260 | 4 |

*Duty 1/10 @ 10Khz

** IR Reflow for no more than 10 sec @ 260 °C

*** Junction to substrate



Dominate Wavelength (nm) Bin:

| Wd (nm) | | | |
|------------|-----------|------|------|
| Color | Code name | Min. | Max. |
| Royal Blue | DA | 450 | 455 |
| | DB | 455 | 460 |
| Blue | DC | 460 | 465 |
| | DD | 465 | 470 |
| | DE | 470 | 475 |
| | DF | 475 | 480 |
| Green | DM | 515 | 520 |
| | DN | 520 | 525 |
| | DP | 525 | 530 |
| Red | A7 | 615 | 620 |
| | A8 | 620 | 625 |
| | A9 | 625 | 630 |

Measurement tolerance is +/- 1nm

Chromaticity Coordinates (PC Amber)

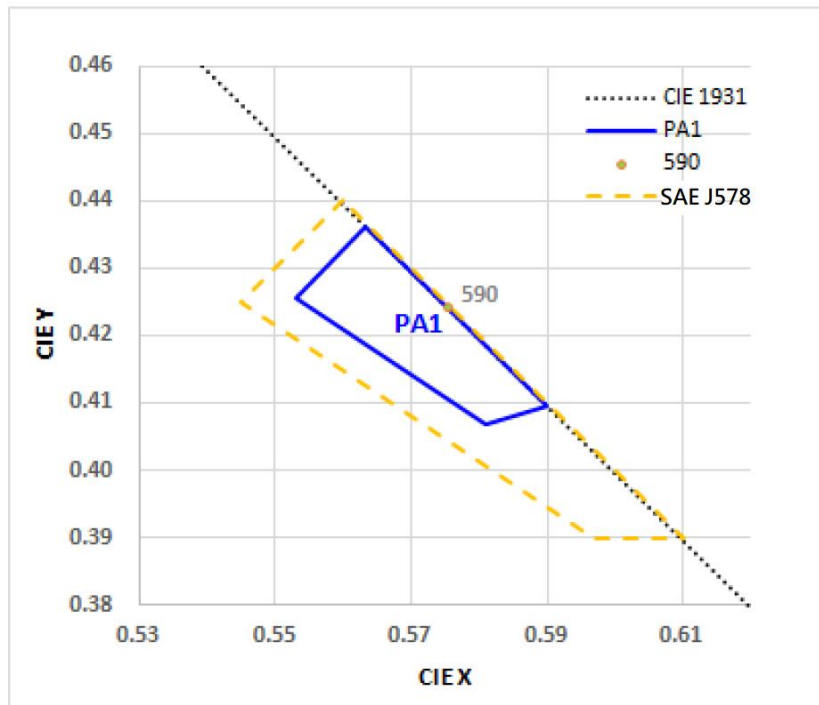

| PC Amber | CIE-X | CIE-Y |
|----------|--------|--------|
| PA1 | 0.5529 | 0.4257 |
| | 0.5811 | 0.4068 |
| | 0.5901 | 0.4094 |
| | 0.5633 | 0.4362 |

Note : 1. Correlated color temperature is derived from the CIE 1931chromaticity diagram
2. CIE measurement tolerance is ± 0.007

Chromaticity Coordinates (Cold White)

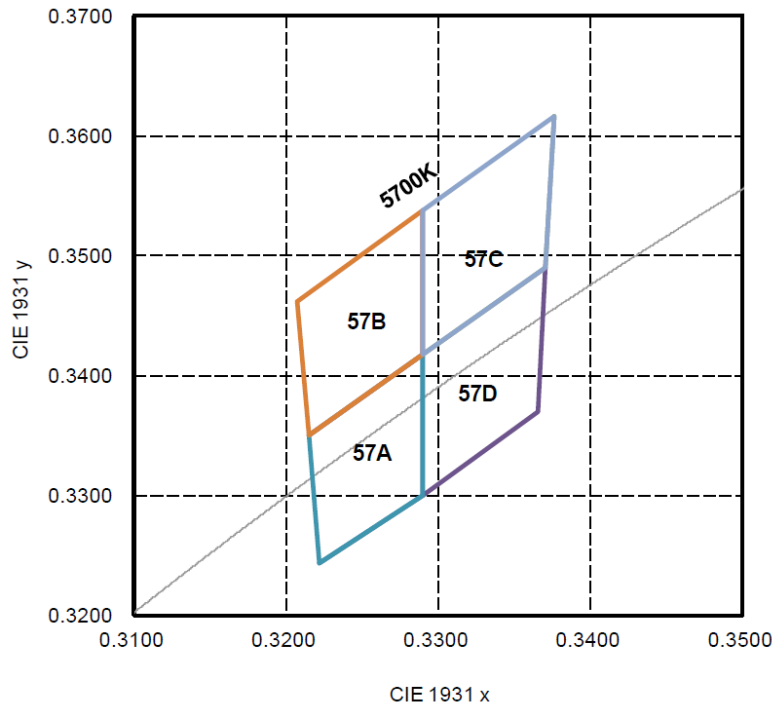

| Rank | CIE-X | CIE-Y | Rank | CIE-X | CIE-Y |
|------|--------|--------|------|--------|--------|
| 57A | 0.3215 | 0.3350 | 57C | 0.3290 | 0.3538 |
| | 0.3290 | 0.3417 | | 0.3376 | 0.3616 |
| | 0.3290 | 0.3300 | | 0.3371 | 0.3490 |
| | 0.3222 | 0.3243 | | 0.3290 | 0.3417 |
| 57B | 0.3207 | 0.3462 | 57D | 0.3290 | 0.3417 |
| | 0.3290 | 0.3538 | | 0.3371 | 0.3490 |
| | 0.3290 | 0.3417 | | 0.3366 | 0.3369 |
| | 0.3215 | 0.3350 | | 0.3290 | 0.3300 |

Note : 1. Correlated color temperature is derived from the CIE 1931chromaticity diagram
2. CIE measurement tolerance is ± 0.007



Forward Voltage (VF) Bin:

| VF Rank (V) | | | |
|---|-----------|-----|------|
| Color | Code name | Low | High |
| Royal Blue/ Blue/ Green/ PC Amber/ Cold White | 01 | 2.8 | 3.0 |
| | 23 | 3.0 | 3.2 |
| | 45 | 3.2 | 3.4 |
| | 67 | 3.4 | 3.6 |
| Red/ | NO | 1.6 | 1.8 |
| | PQ | 1.8 | 2.0 |
| | RS | 2.0 | 2.2 |
| | TU | 2.2 | 2.4 |
| | VW | 2.4 | 2.6 |

The forward voltage tolerance is $\pm 0.1V$

Luminous Flux Bin:

| Rank @350mA (lm) | | | |
|------------------|-----------|-----|------|
| Color | Code name | Low | High |
| Royal Blue | QE9 | 10 | 20 |
| | QJ9 | 20 | 30 |
| | QN9 | 30 | 40 |
| Blue | QN9 | 30 | 40 |
| | QP9 | 40 | 50 |
| Green | QX9 | 100 | 110 |
| | QY9 | 110 | 120 |
| | QZ9 | 120 | 130 |
| PC Amber | QX9 | 100 | 110 |
| | QY9 | 110 | 120 |
| Red | QT9 | 60 | 70 |
| | QU9 | 70 | 80 |
| Cold White | Q19 | 140 | 150 |
| | Q29 | 150 | 160 |
| | Q39 | 160 | 170 |

luminous flux tolerance is $\pm 7\%$



Characteristic Curves

(1) Color Spectrum

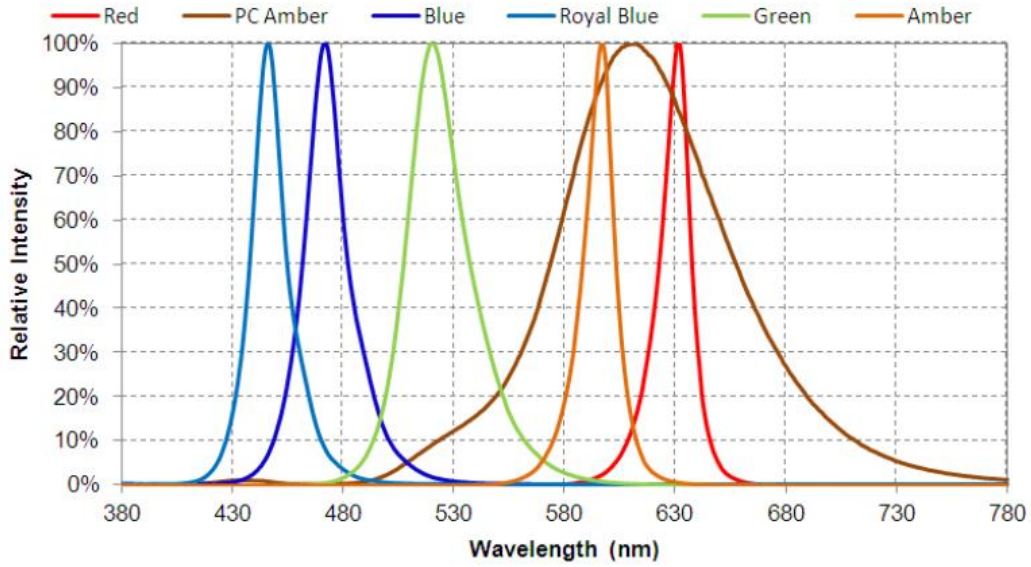

(2). Typical Representative Spatial Radiation Pattern

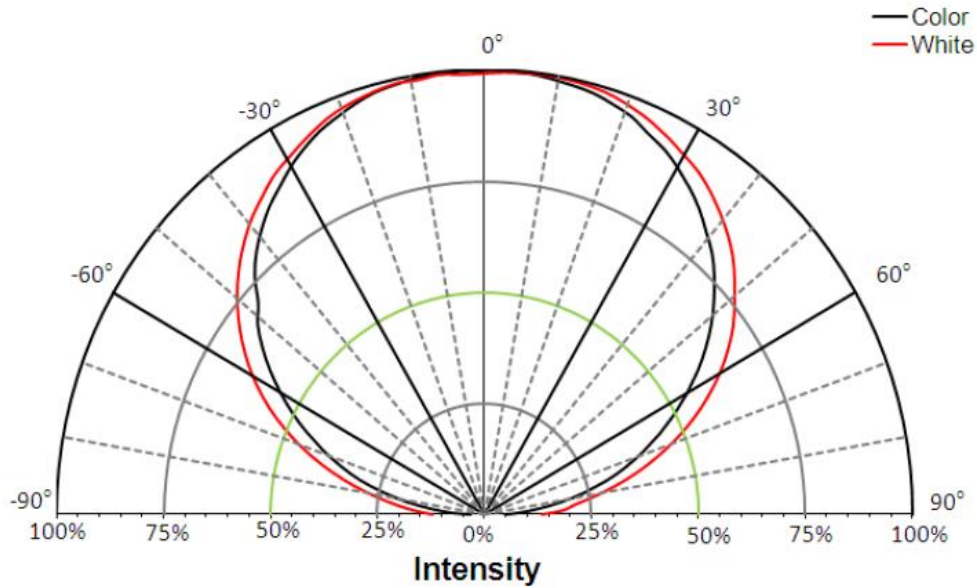

(3). Forward Current Characteristics

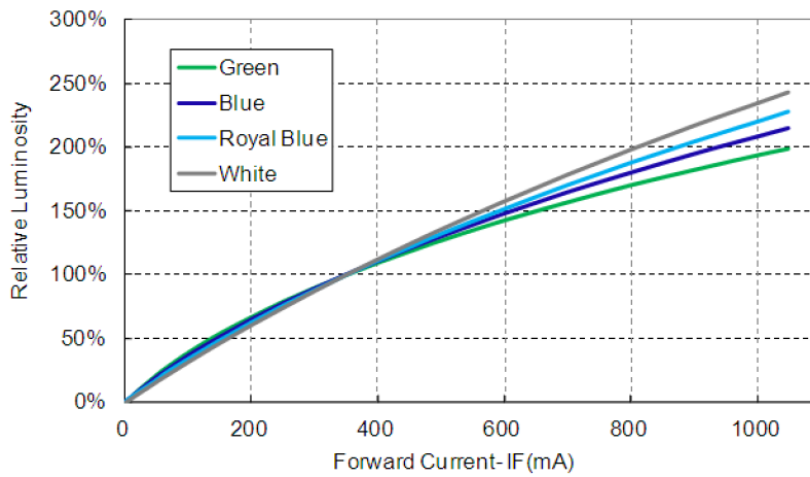
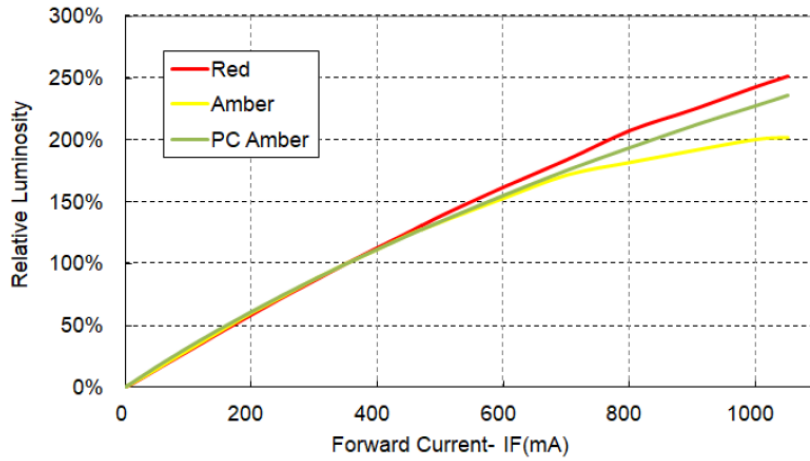

(4). Forward Current vs Forward Voltage

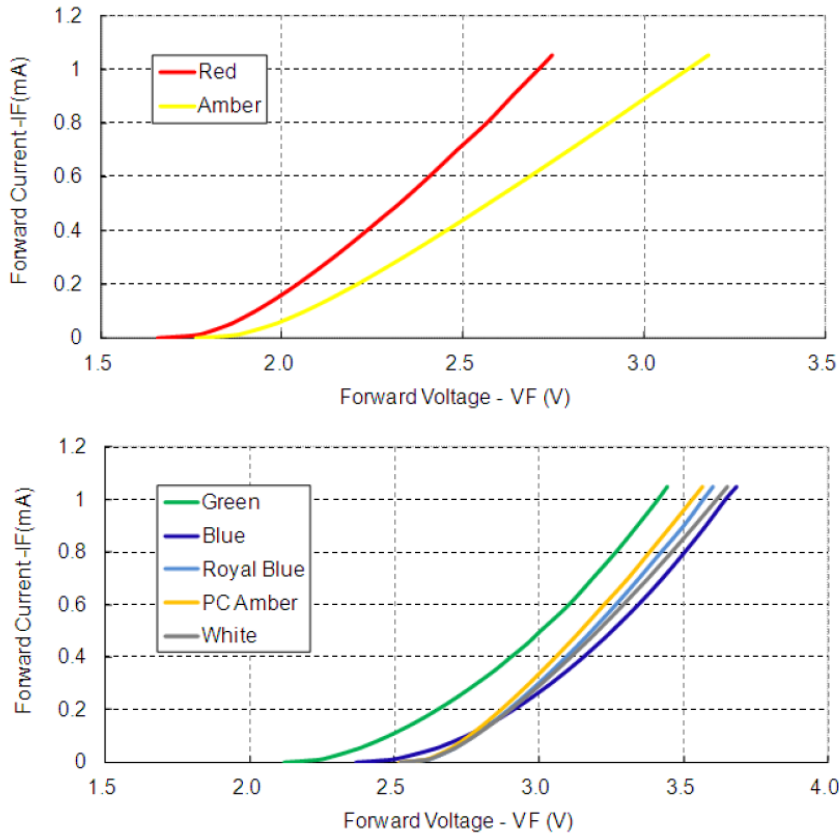

(5). Relative light output VS. Tj (IF = 350mA)

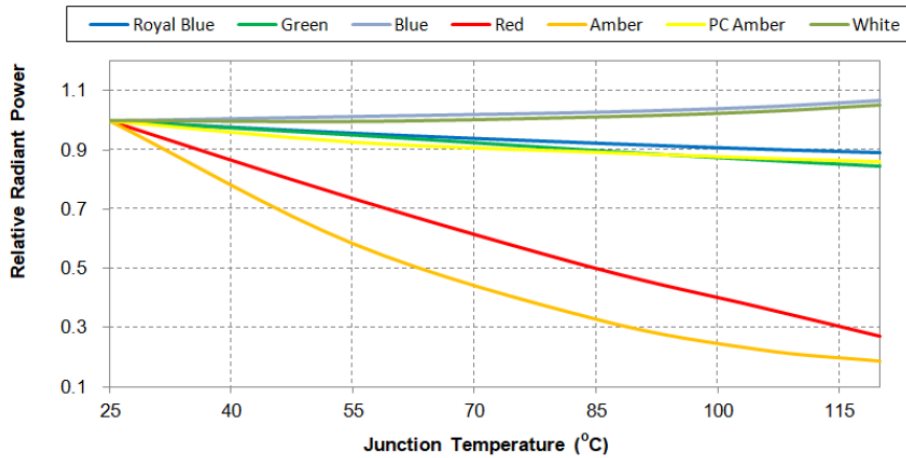

■ Reliability test:

| No | Item | Condition | Time/Cycle | Sample size |
|----|--|---|------------|-------------|
| 1 | Steady State Operating Life of Room Temperature | 25°C Operating | 1000 Hrs | 20 pcs |
| 2 | Steady State Operating Life of Low Temperature -40°C | -40°C Operating | 1000 Hrs | 20 pcs |
| 3 | Steady State Operating Life of Low Temperature 60°C | 60°C Operating | 1000 Hrs | 20 pcs |
| 4 | Steady State Operating Life of Low Temperature 85°C | 85°C Operating | 1000 Hrs | 20 pcs |
| 5 | Low temperature storage -40°C | -40°C Storage | 1000 Hrs | 20 pcs |
| 6 | High temperature storage 100°C | 100°C Storage | 1000 Hrs | 20 pcs |
| 7 | Steady State Operating Life of High Humidity Heat 60°C 90% | 60°C/90% Operating | 1000 Hrs | 20 pcs |
| 8 | Steady State Pulse Operating Life Condition | 25°C 10Hz duty=1/10 Operating | 200 Cycle | 20 pcs |
| 9 | Resistance to soldering heat on PCB (JEDEC MSL3) | pre-store@60°C, 60%RH for 52hrs T _{sld} max.=260 10sec | 3 Times | 20 pcs |
| 10 | Heat Cycle Test (JEDEC MRC) | 25°C~65°C~-10°C, 90%RH, 24hr/1cycle | 10 Cycle | 20 pcs |
| 11 | Thermal shock | -40°C/ 20minr~ 5minr~100°C /20min | 300 Cycle | 20 pcs |

■ Judgment Criteria:

| Item | Symbol | Test Condition | Judgment Criteria |
|-----------------|----------------|----------------|-----------------------|
| Forward Voltage | V _f | 350 mA | ΔV _f < 10% |
| Luminous Flux | I _v | 350 mA | ΔI _v < 30% |



Solder Profile:

-The recommended reflow soldering profile is as follows (temperatures indicated are as measured on the surface of the LED resin):

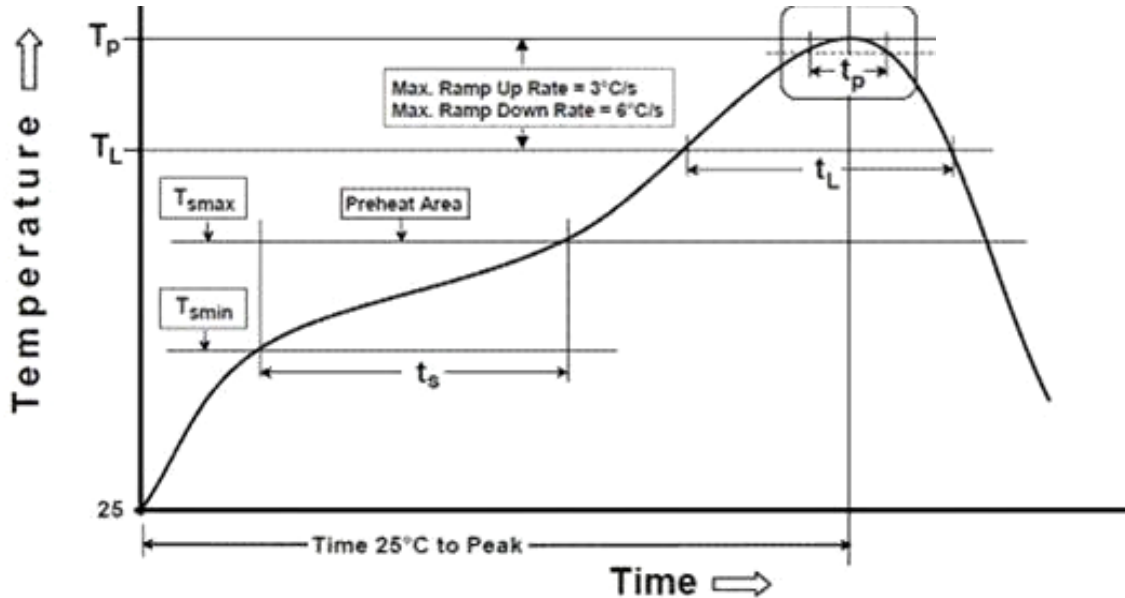

| Profile Feature | Sn-Pb Eutectic Assembly | Pb-Free Assembly |
|---|-------------------------|------------------|
| Temperature Min(T_{smin}) | 100°C | 150°C |
| Temperature Max(T_{smax}) | 150°C | 200°C |
| Time(t_a) from (T_{smin} to T_{smax}) | 60-120 seconds | 60-120 seconds |
| Ramp-up rate(T_L to T_P) | 3°C/second max. | 3°C/second max. |
| Liquidous Temperature(T_L) | 183°C | 217°C |
| Time(t_L) maintained above T_L | 60-150 seconds | 60-150 seconds |
| Peak package body temperature(T_P) | 235°C | 260°C |
| Time within 5°C of Actual Peak temperature (t_p) | 20seconds* | 30 seconds* |
| Ramp-down rate(T_P to T_L) | 6°C/second max. | 6°C/second max. |
| Time 25°C to peak temperature | 6 minutes max. | 8 minutes max. |
| * Tolerance for peak profile temperature (T_P) is defined as a supplier minimum and a user maximum. | | |



Taping & Packing:

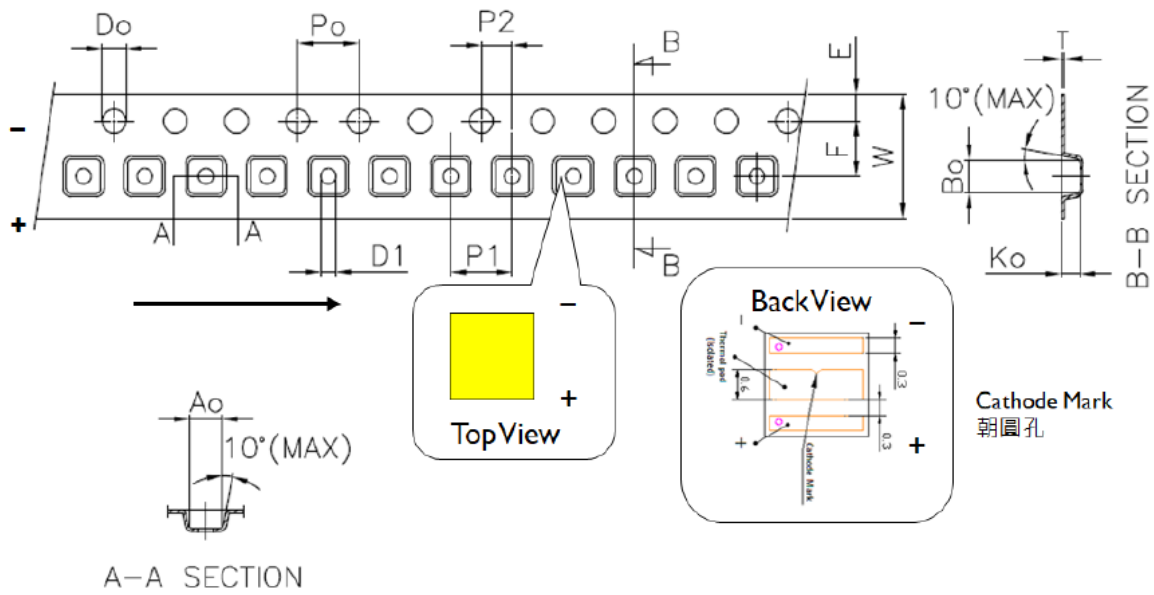

| | | | | | | | |
|--------|-----------|-----------|-----------|-----------|-----------|------------|-----------|
| symbol | Ao | Bo | Ko | Po | P1 | P2 | T |
| spec | 2.25±0.10 | 2.25±0.10 | 1.22±0.10 | 4.00±0.10 | 4.00±0.10 | 2.00±0.05 | 0.25±0.05 |
| symbol | E | F | Do | D1 | W | 10Po | |
| spec | 1.75±0.10 | 3.50±0.05 | 1.55±0.05 | 1.00±0.10 | 8.00±0.30 | 40.00±0.20 | |

unit : mm



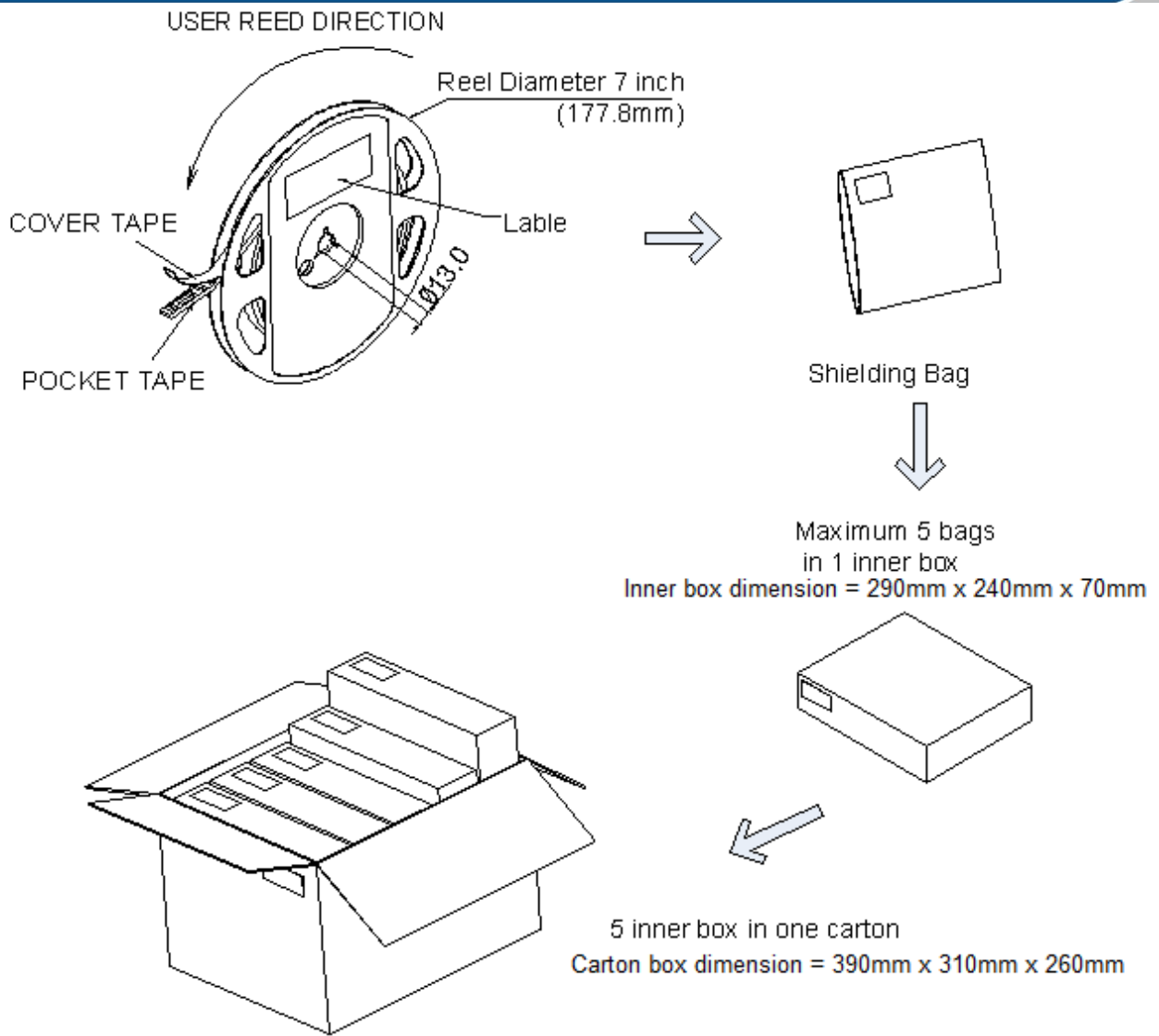

Labeling

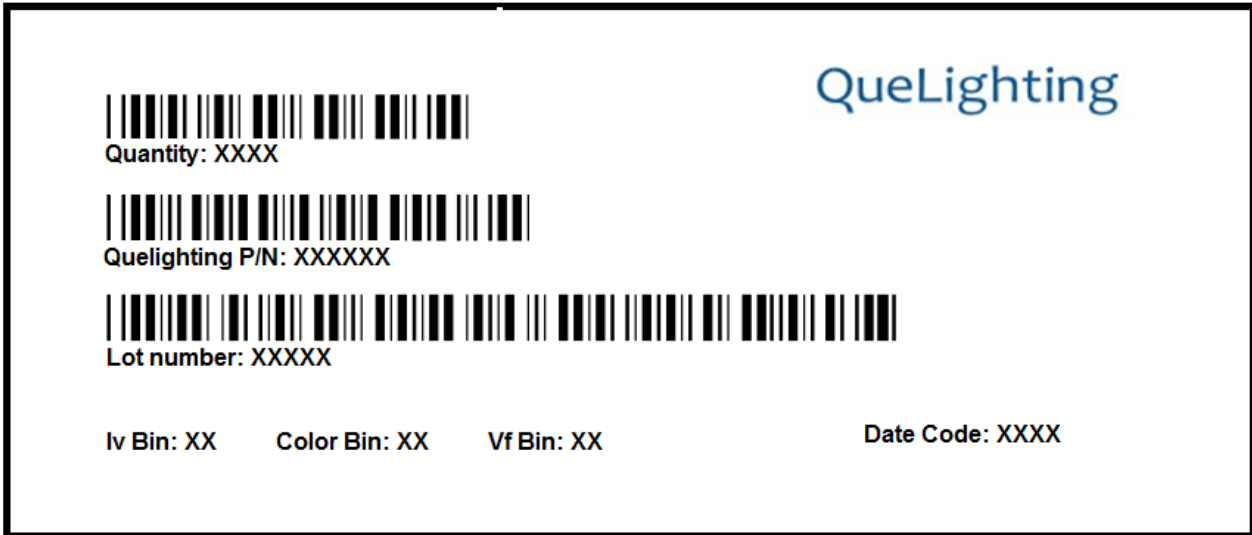

Ordering Information:

| Part # | Multiple Quantities | Quantity per Reel |
|----------------|---------------------|-------------------|
| QLSP20XXEU-309 | | 500/1000 pcs |
| | | |
| | | |
| | | |



Revision History:

| Revision Date: | Changes: | Version #: |
|----------------|-----------------|------------|
| 06-16-2021 | Initial release | 1.0 |
| | | |
| | | |
| | | |

